

VAKO

BLIND / CURTAIN
COMPONENTS

20/04

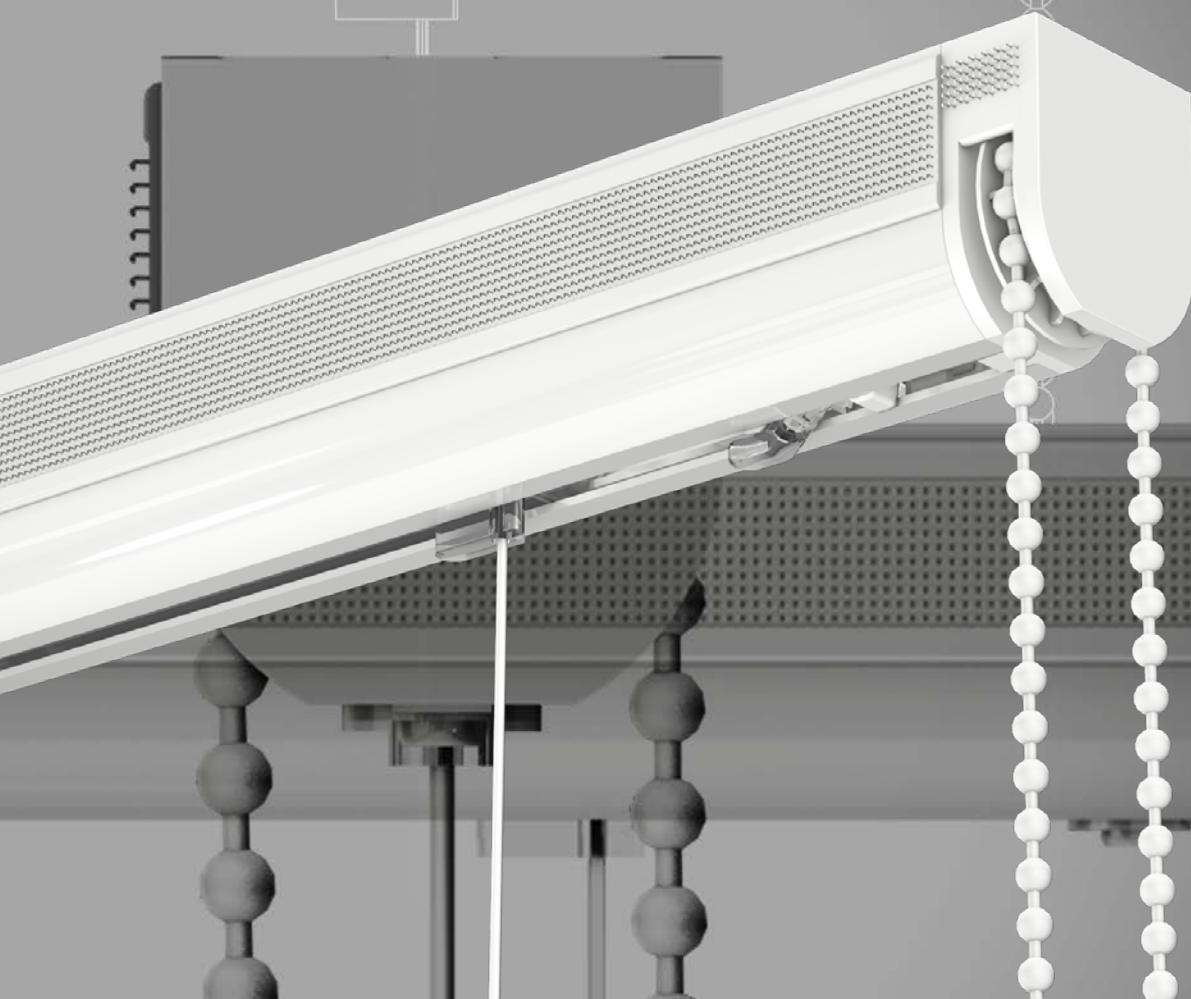

DUTCH
DESIGN

20/04 ROMAN BLIND

WWW.VAKO.COM

somfy.
compatible

ULTIMATE ROMAN BLIND

ONE PROFILE
MULTIPLE APPLICATIONS



CHAIN

- 1:1 - max 6 kg / 14 lbs
- 1:4 - max 8 kg / 18 lbs
- Control unit with easy clickable endcap



SPRING

- Patented technique
- Unique EASYBALANCE® cord drum
- Adjust to width and height
- Up to 5KG and 6 m2

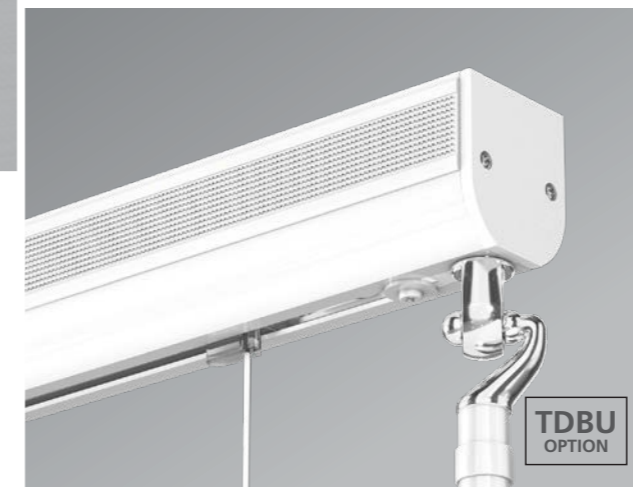

CRANK ROD

- 1:1 - max 8 kg / 18 lbs
- 1:4 - max 10 kg / 22 lbs
- Ultra light operation
- Made to measure rod length
- Removable crank rod
- Child safe

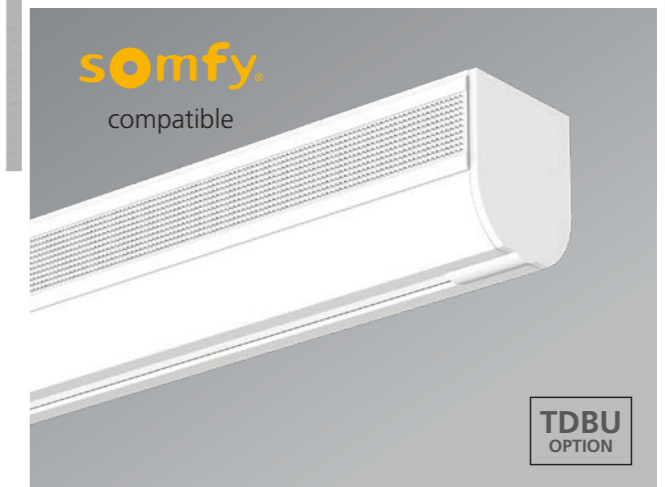

MOTOR

- Built in battery
- Suited for both side and middle motor
- Compatible with Somfy 12V

EASYSAFE® CONTROL UNIT

STANDARD CONTROL UNIT

- 1:1 - max 6 kg / 14 lbs
- 1:4 - max 8 kg / 18 lbs
- Control unit with easy clickable endcap

TDBU
OPTION

CHAIN CONTROL OPTIONS



BUDGET



STANDARD



EASY SAFE

- Control unit 1:1 for fast operation
- Control unit 1:4 for a weight up to 10 kg / 22 lbs

INTERNAL BREAKAWAY MECHANISM

Chain cog only releases in dangerous situations, not daily use. After release the chain cog can be placed back into the gear house very easily

Child safe in compliance with European legislation



20/04 CRANK ROD

RE-DESIGNED HOOK & EYE

- 1:1 - max 8 kg / 18 lbs
- 1:4 - max 10 kg / 22 lbs
- Ultra light operation
- Made to measure rod length
- Removable crank rod



TDBU
OPTION

EASYLOCK CORDDRUM PREFERED FOR FASTER ASSEMBLY



- 20% Faster assembly
- Fasten in 1 click
- No screws
- Removable cord

EASYLOCK®

Patented by Vako

MADE TO MEASURE CRANK ROD

3 parts for quick and adjustable assembling. A hook, made to measure rod and handle part. Max. length of the adjustable rod is 3000 mm.



- 1 Hook
- 2 M2M rod
- 3 Handle



20/04 SPRING

CHAIN- / CORDLESS CONTROL

- Patented technique
- Unique EASYBALANCE® cord drum
- Adjust to width and height
- Up to 5KG and 6 m2

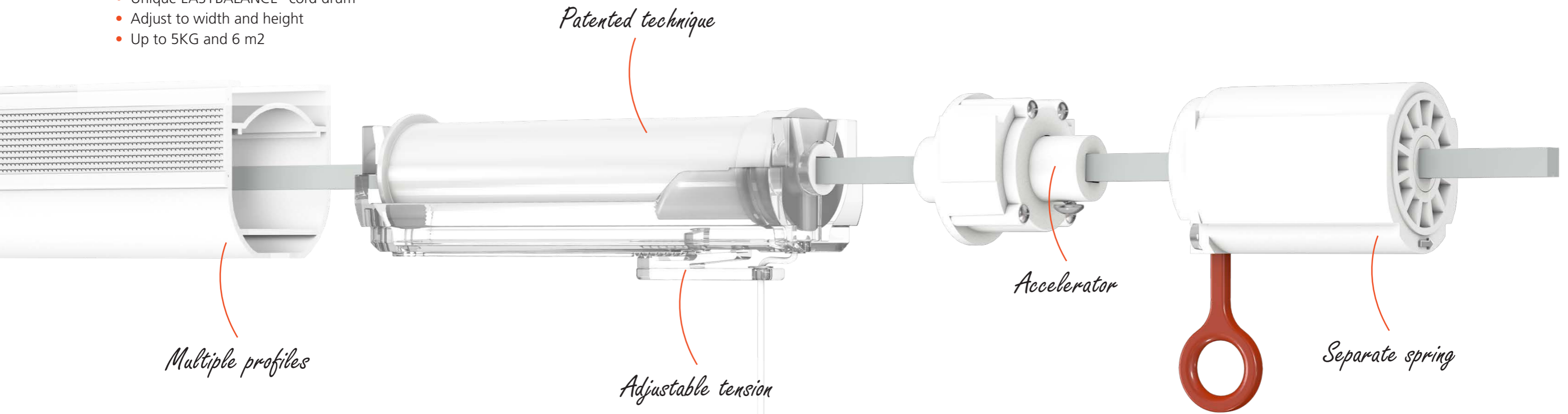

NEW
PATENTED INNOVATION

SPRING TECHNIQUE

- Separate springs
- Easily add spring for extra power
- 2 spring types to cover complete range
- Cord drum for fine-tune balance



EASYBALANCE®

Patented by Vako

20/04 MOTORIZED

INTEGRATED MOTOR

- Designed for both middle and side motor
- Direct 12V transformer operated
- Built in battery
- 12 V, up to 6 kg / 13.23 lbs
- Compatible with Somfy 12V

somfy
compatible

PREFERRED CORDDRUM FOR FASTER ASSEMBLY

- 20% Faster assembly
- Fasten in 1 click
- No screws
- Removable cord



MOTORIZED OPTIONS

MIDDLE MOTOR



SIDE MOTOR



BUILT IN BATTERY PACK 12 V

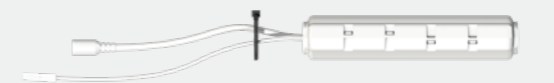

REMOTE



amazon

 Microsoft



EASYLOCK®

Patented by Vako

CONNECTOR

Connects both headrail and shaft

- Less waste
- Easily connects headrail and shaft
- Handling and storage advantage
- Economic transport

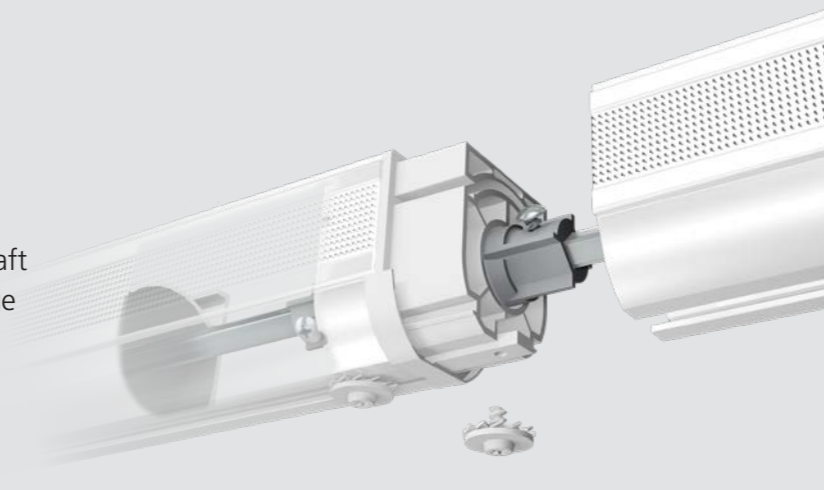

PROFILE

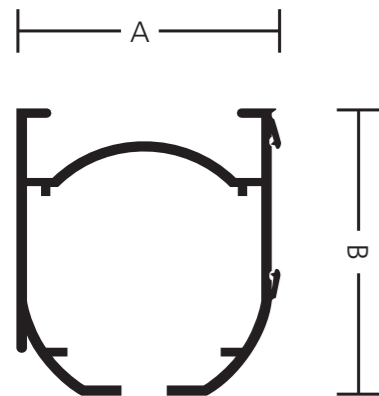

	Size A	Size B	Length	Weight pm
Europe	35 mm	38 mm	5800 mm	0,47 Kg
US	1 ³ / ₈ "	1 ¹ / ₂ "	19 ft	1,04 lbs

Multiple lengths available for economic transport

Material Aluminium
Colour White, grey and black

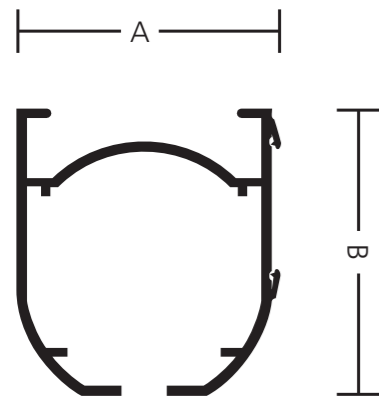

	Size A	Size B	Length	Weight pm
Europe	35 mm	38 mm	5800 mm	0,38 Kg
US	1 ³ / ₈ "	1 ¹ / ₂ "	19 ft	0,83 lbs

Multiple lengths available for economic transport

Material Aluminium
Colour White



EXPLODED VIEW



- | | | |
|-------------------|-------------------------|----------------------|
| 1 Bracket | 4 Easysafe control unit | 7 Square shaft |
| 2 Easylock endcap | 5 Releasable chain cog | 8 Easylock cord drum |
| 3 Head profile | 6 Endless chain | |

BRACKETS

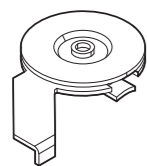

Ceiling
White

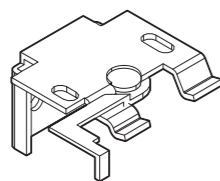

Wall ceiling swivel
White

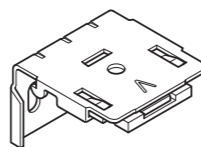

Wall ceiling click
White, grey

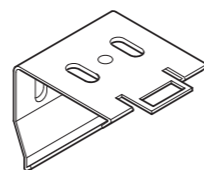

Wall ceiling spring
White, grey

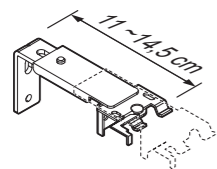

Ceiling
White

RODS

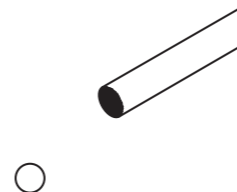

Fibre
White
Ø 4mm

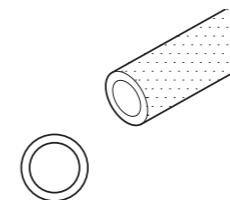

Aluminium
White, grey anodised, black
Ø 6mm

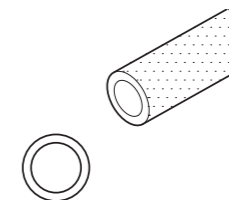

Aluminium
Grey anodised
Ø 8mm

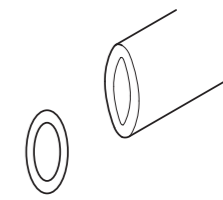

Plastic
Transparent
10x3mm

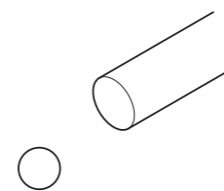

Plastic
Transparent
Ø 5mm

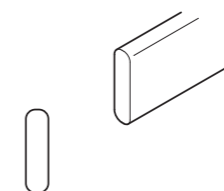

Fibre
White
10x2,7mm

CORD DRUMS

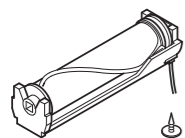

Standard cord

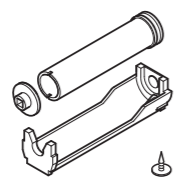

Standard

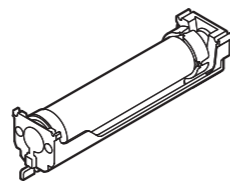

Easylock®

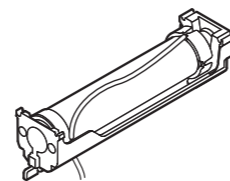

Easylock® cord

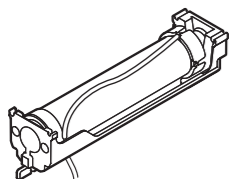

Easylock® fixed cord

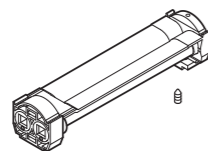

Double TDBU

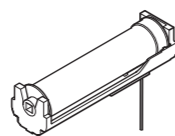

Easybalance®

WEIGHT BARS

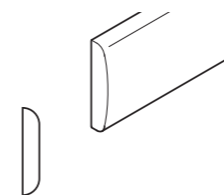

Aluminium
White, grey anodised
2x4mm

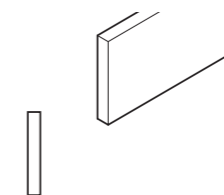

Aluminium
White, grey anodised
2 x3mm

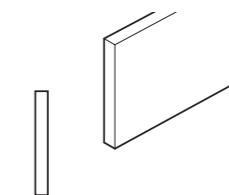

Aluminium
White, grey anodised
25x3mm

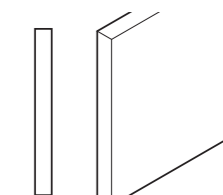

Aluminium
White
40x4mm

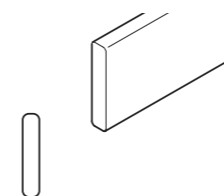

Fibre
White
20x4mm

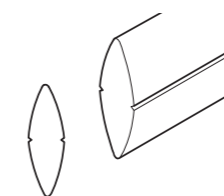

PVC
White
27x9mm

VAKO

BLIND / CURTAIN
COMPONENTS



EUROPE • NORTH AMERICA • ASIA-PACIFIC

EUROPE HQ

Goudenhevel 47
5234 GA 's-Hertogenbosch
The Netherlands
info@vako.com
www.vako.com

NORTH AMERICA

6844 Schneider Rd. unit B
Middleton, WI 53562
USA
info@vako-us.com
www.vako-us.com